



Style Secured.



Style **Secured**



Established **1997**



WELCOME TO **ROCKDOOR**

Rockdoor has been the driving force behind composite doors for well over 25 years. During that time, almost a million doors have been produced, keeping families safe and secure across the country.

THE ORIGINAL COMPOSITE DOOR

We are proud to offer a comprehensive collection of door styles, colours and glass designs which are exclusive to Rockdoor. From the detailing of our door mouldings through to our stunning 3D glass designs, you won't find them anywhere else but Rockdoor.

STYLE SECURED

We use solid steel for our hook locks, reinforced aluminium box section for our inner frame, steel reinforcement for our outer frame, 3-star locking cylinders, high impact PVC-U for our skins and a unique S-Glaze system that locks the glass into your door for life.

Security is in our DNA.





3D
GLASS

Vogue - White - Shade Glass



VOGUE

The Vogue is one of our most popular door styles and will certainly help you stand out from the crowd. The Shade (left) provides more than just a contemporary door style, but also adds an extra layer of privacy through a mixture of sandblasted and sandstone glass.



Vogue - Anthracite Grey - Cube Glass

3D
GLASS



Vogue - Agate Grey - Cube Glass

VOGUE

Perfectly suited for both modern properties for an extra bit of flair, or even to create a bold statement on traditional homes, the Vogue truly is one of a kind.



Vogue - White- Haze Glass

The Cube (left) is one of our most popular glass styles for the Vogue and it is no wonder! Thanks to its intricate level of privacy, carved using a 3D glass design, striking the ultimate balance between privacy and style. We would recommend viewing this door style on our 3D designer to truly appreciate the effect of the Cube glass design.

VOGUE



Vogue - Anthracite Grey - Optima Glass



Vogue - Black - Ocean Glass



Vogue - White - Fluid Glass



Manhattan - White - Misted Glass



MANHATTAN

The aptly named Manhattan, is a hugely popular style at Rockdoor. This contemporary design features 5 delicately proportioned square glazing panels, which are lined through the centre of the door. All the glazing panels feature S-Glaze technology for the ultimate advance in security, meaning the glass is part of the door itself and not clipped in afterwards using a cassette.



Manhattan - Irish Oak - Curve Glass





JACOBEOAN

Simple yet stunning. The Jacobean is an incredibly versatile door style with two symmetrical glass panes running half way down the door, incorporating plenty of natural light into any home, creating a spectacular entrance for the front, back or even the side of your house!



Jacobean - Irish Oak - Empire Glass

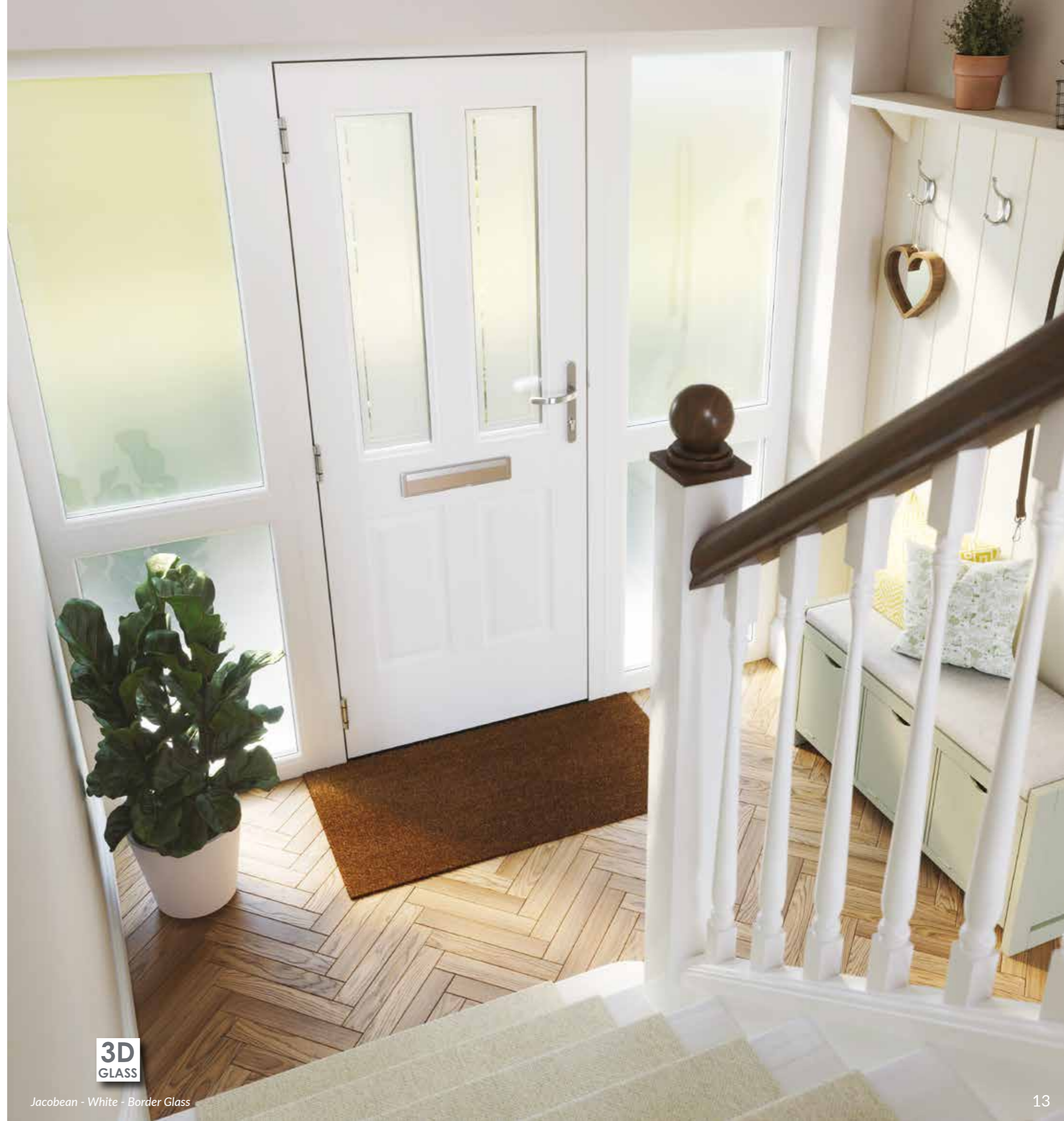

Jacobean - White - Border Glass



3D
GLASS

Jacobean - Agate Grey - Shade Glass



Jacobean - Chartwell Green - Inspire Glass

JACOBEAN

Combine this hugely popular door style with our Shade glass design for the ultimate contemporary finish. Another beautiful glass style that can be fully appreciated on our 3D door designer on rockdoor.com along with many more.



Jacobean - Black - Apollo Glass



NEWARK

Old meets new in this modern take on a traditional style. The Newark's moulding lines blend classic design elements with contemporary manufacturing.

This is demonstrated by the Newark Jubilee (right), a traditional door style that will complement any property but also incorporates modern security details, including our burglar proof multi-point locking system, as standard with every style.

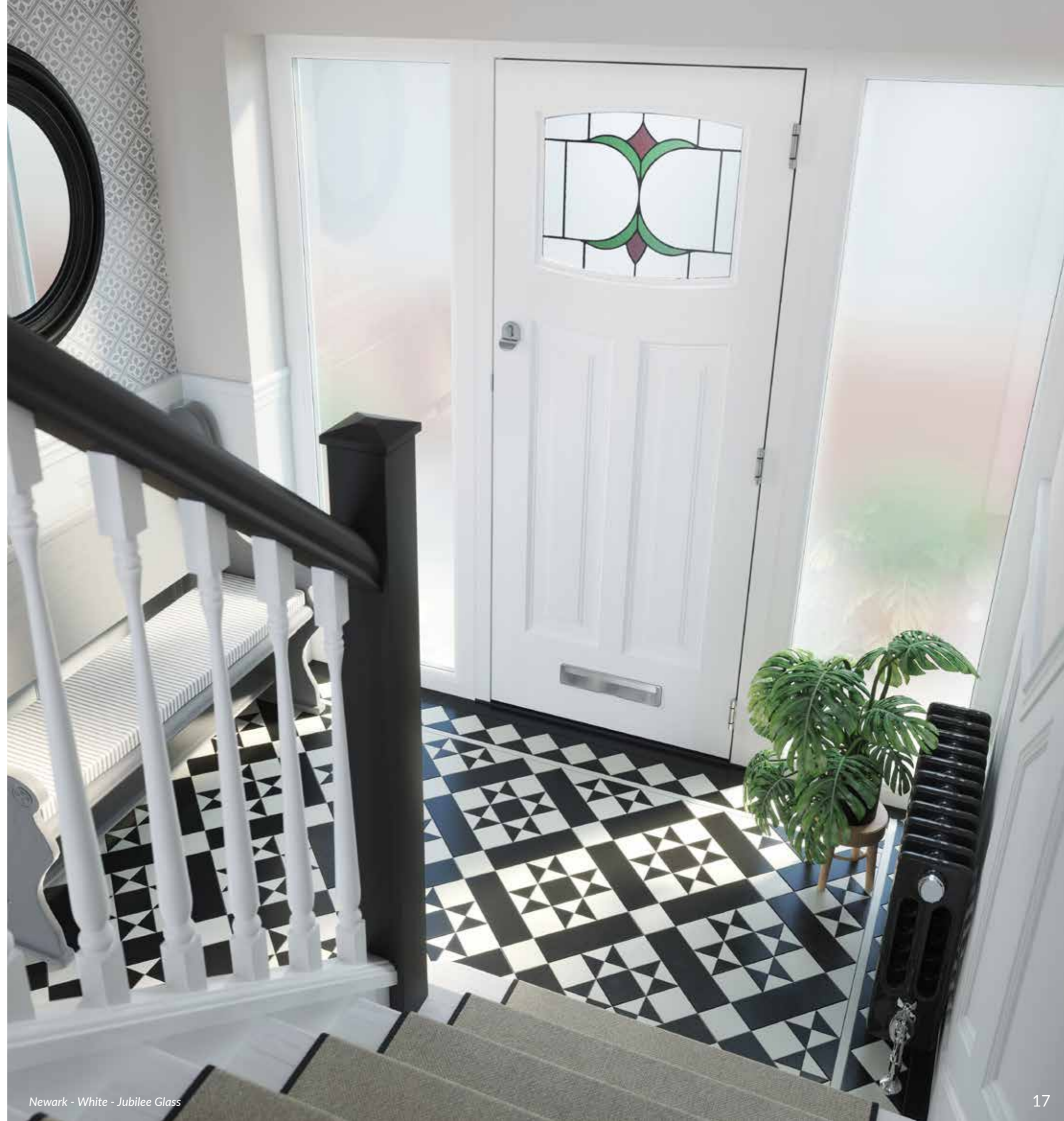



3D
GLASS

Newark - Black - Iris Glass



Newark - White - Bright Star Glass

NEWARK

Thanks to the traditional elements of the door, the Newark is the perfect family door for those looking to mix style with any setting and goes perfectly with our new Heritage Plus lock, which is available on the majority of our Rockdoor styles (see page 73 - Instant Lock).

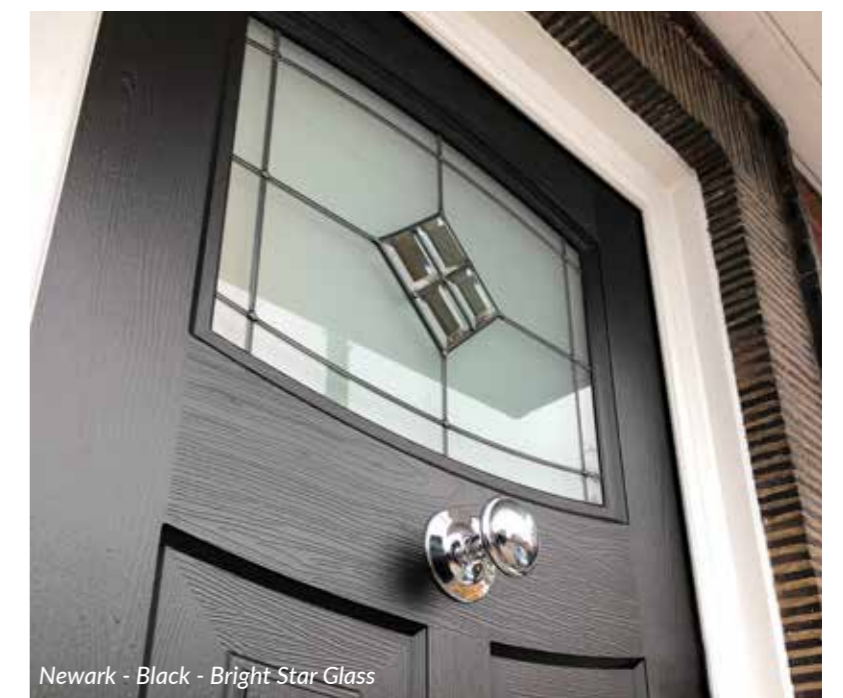

Newark - Black - Bright Star Glass



3D
GLASS

Vermont - Agate Grey - Haze Glass



VERMONT

Unique to Rockdoor, the contemporary Vermont suits a wide variety of properties thanks to its long narrow glass aperture and sophisticated moulding detail. Combine the Vermont with one of our stylish bar handles for a contemporary finish (see page 73).



Vermont - White - Haze Glass

3D
GLASS

VERMONT

Its modern design makes it a firm favourite with homeowners around the country and looks fantastic in a wide range of colours from Agate Grey through to Light Oak.



Vermont - Anthracite Grey - Grey Shades Glass



Vermont - Anthracite Grey - Continuity Glass



Vermont - Agate Grey - Continuity Glass



3D
GLASS

Vermont - Anthracite Grey - Shade Glass



3D
GLASS

Vermont - Light Oak - Haze Glass

VERMONT

Synonymous with style and flair, the Vermont truly captures the essence of Rockdoor in a single and stunning contemporary entrance door.



ASPEN

An entirely new style for us, the Aspen brings something unique to the Rockdoor family.

Combining traditional vertical mouldings and a modern yet distinctive glazing panel, the Aspen is suitable for all lock types, giving you even more choice with this contemporary style, that doubles up as the perfect front or back door.



Aspen - White - Clear Glass



Aspen - White - Misted Glass



Indiana - Anthracite Grey



INDIANA

The slick lines of the Indiana have made it one of the most popular styles Rockdoor manufacture. When combined with a stainless steel bar handle, a knocker and a letterplate the results are phenomenal.

Solid doors can be paired perfectly with wire mesh reinforcing, for an optional but added extra touch of security. So, for a stylish, secure and energy efficient door, the Indiana fits the profile perfectly.



Indiana - Light Oak



DAKOTA

The Dakota's elegance is created using 4 square mouldings running down the centre of the door. Another solid door choice which excels in performance with wire mesh reinforcing, commonly used in conjunction with side panels, and often finished off with our bar handle range (page 68).



Dakota - Black



Dakota - White



ILLINOIS

The Illinois is similar in style to one of our best-selling doors, the Jacobean, but features slightly longer glass apertures and a delicate swept head.

Choose from 3 stunning glass designs shown here, or even sandblasted glass for a contemporary finish.



Illinois - Irish Oak - Empire Glass



Illinois - Light Oak - Pinnacle Glass



Portland - White - Beacon Glass



PORTLAND

If your priority is letting light in, look no further than the Portland. As well as the security of S-Glaze glass, you've the option of ornate glass bevels and stunning gluechip glass to provide an astounding combination of both traditional and contemporary.

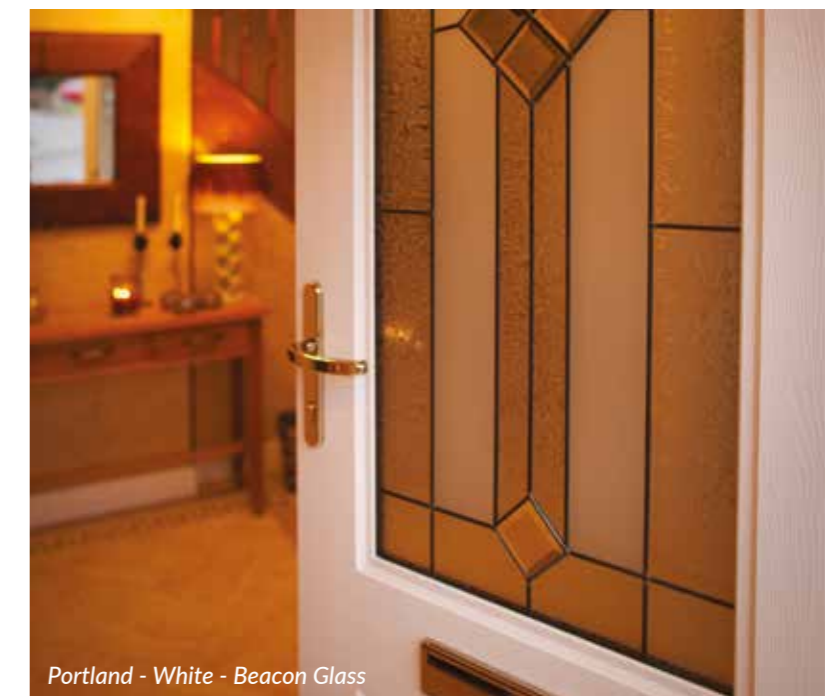

Portland - White - Beacon Glass



CAROLINA & TENNESSEE

Similar in style, the Carolina and Tennessee are popular door styles for homeowners looking for a traditional effect entrance door. The Carolina features a Georgian look and feel to the glazing aperture and provides high levels of privacy, whereas the Tennessee lets in more light and is available with a wide range of glass designs.



Tennessee - Chartwell Green - Crystal Bevel Glass



Carolina - White - Misted Glass



WINDSOR

The Windsor features a large glazing aperture to incorporate natural light into any home, which can be perfectly combined with a low aluminium threshold for easy kitchen and laminate floor entrances.



Windsor - Ruby Red - Crystal Bevel Glass



Windsor - White - Clear Glass



COLONIAL & REGENCY

Both the Colonial and Regency are both intricately designed, perfect for those conscious of privacy but still wanting a traditional style of door.



Colonial - Anthracite Grey



Regency - Black - Clear Glass



ARCACIA & KENTUCKY

Go traditional with the Arcacia door style, which has over recent years been a firm favourite amongst Rockdoor customers thanks to its timber effect appearance. Much like the Kentucky which features a large arched piece of glazing to allow natural light to enter any home.



Arcacia - Irish Oak - Summit Glass



GEORGIA & MONTANA

Almost identical by the mouldings, the Georgia features a larger pane of glass, complemented by traditional curved panels. The Montana contains a smaller, oval shaped piece of glass to fully highlight the elegance in the design surrounding it.



Georgia - Black - Clear Glass



English Cottage - Agate Grey - Clear Glass



ENGLISH COTTAGE

A classic door style that has constantly retained its popularity. The English Cottage features a narrow mid rail and a curved top moulding detail to complement a perfectly sized piece of glass that all works collectively to create a truly beautiful entrance door.



English Cottage - Light Oak - Rectangular Leading Glass



COTTAGE (SPY & VIEW LIGHT)

The Spy View features a deeper mid rail alongside a straight top moulding detail and the aptly named pane of glass. The View Light replaces the top mouldings with a larger glass unit, flooding natural light into any home.



Cottage Spy - Black - Gluechip Glass



Cottage Spy - White - Clear Glass



STABLE (VIEW LIGHT & SPY)

Stable doors add charm and convenience, so it's no surprise that they're such a firm favourite. They allow the outside into any home by acting as both a door and a window.



Stable View Light - White - Clear Glass



Stable View Light - White - Clear Glass



Stable Spy - White - Misted Glass

STABLE DOORS

PRACTICAL

A slide bolt allows you to operate the top of the door independently of the bottom of the door, helping you bring the outside in. It's also a great way to keep pets inside whilst letting fresh air in.

UNIQUE & SECURE

Our tried and tested custom-made centre seal ensures the door acts as one so you don't have to worry about leaks. Stable door locks are just as strong as our other doors and feature specially made multipoint locks (top and bottom) and a strong deadbolt to keep you secure.



Stable View Light - Light Oak - Clear Glass



FRENCH DOORS

Rockdoor French Doors were the first in the industry to achieve the Secured by Design accreditation for safety and security, which means you don't have to compromise on safety.

Multipoint locks, deadbolts and high security hinges are combined with shoot bolts which engage into the top and bottom of the outerframe for total security.



Classic French - White - Clear Glass



DOUBLE DOORS

Double the style to create a stunning first impression, with Rockdoor Double Doors. Nearly all of our door styles can be made into a double door for the ultimate entrance. Please speak to your installer for more details.



Vermont Double - Black - Grey Shades Glass



Vermont Double - Irish Oak - Clear Glass



Vogue Double - Rosewood - Optima Glass

3D
GLASS



INTRODUCING THE DUNE

For years, composite doors have tried to replicate timber doors. But ultimately, woodgrain doesn't always suit modern doors. This led Rockdoor to design a new texture called the Dune, designed with contemporary homes in mind.

Our industry first door texture completely rips up the composite door rule book to create a stunning, ultra-modern look, reminiscent of sand dunes.

The unique texture runs from the sides of the door towards the glazing aperture, where it cleanly falls away into the glass to form a perfect seal.

Exclusive to ROCKDOOR.



DUNE VISION

With a tall glass aperture running almost the entire length of the door, the Dune Vision is designed to not only look breath-taking, but to flood copious amounts of light into any hallway, allowing homeowners to create a fresh, bright and welcoming entrance.



Dune Vision - White - Misted Glass

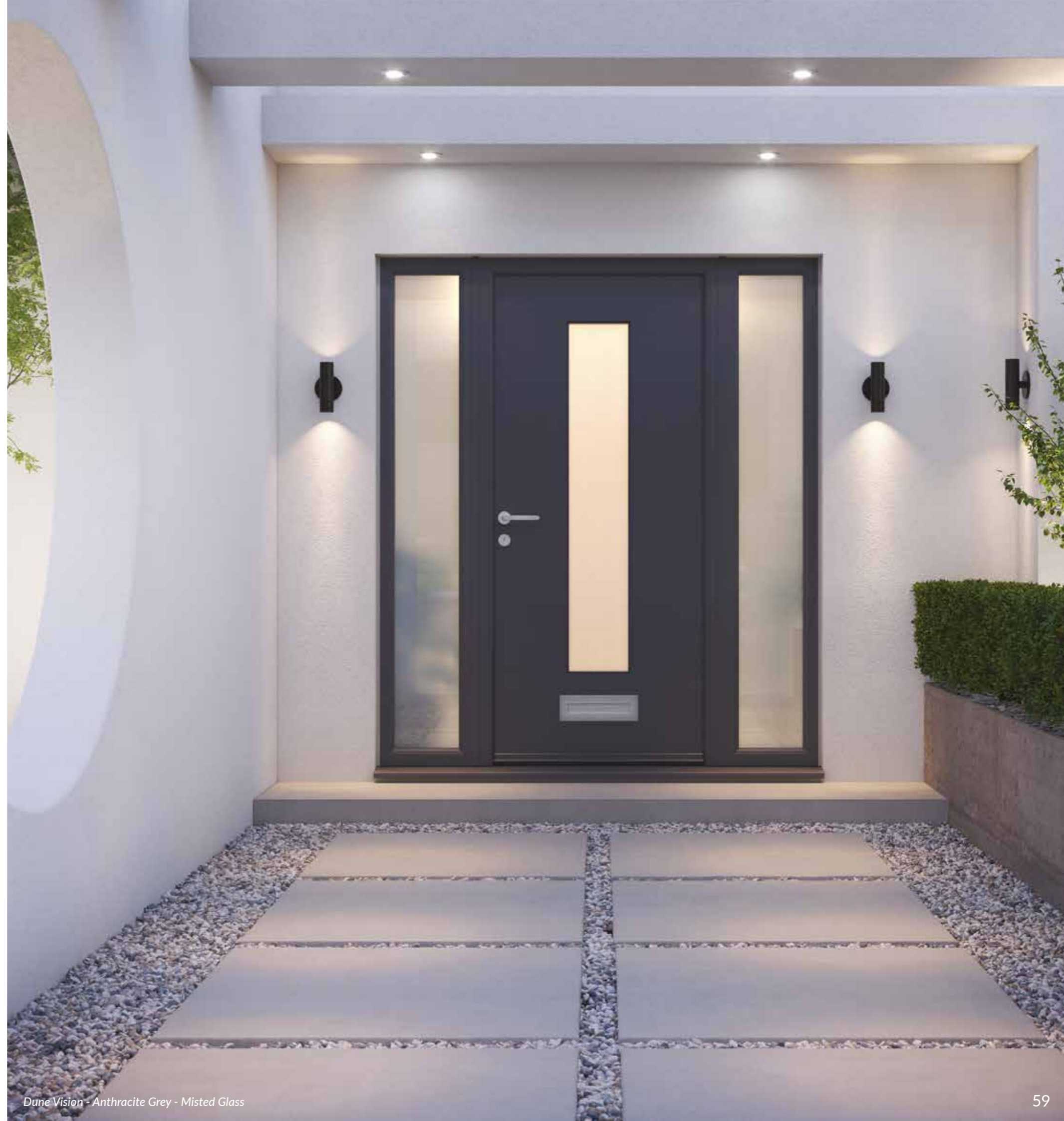

Dune Vision - Anthracite Grey - Misted Glass



Dune Retreat - White - Misted Glass



DUNE RETREAT

For homeowners looking for a door that provides contemporary style whilst retaining a level of privacy, then the Dune Retreat is unmatched. Featuring an ultra-slender glass aperture little over 100mm wide, this door can be matched with Reeded glass, providing a glazing pattern that runs perpendicular to the door texture to create a stylish combination.



Dune Retreat - White - Misted Glass

DECISIONS, DECISIONS...

CHOOSE YOUR COLOUR

Rockdoors are available in 13 colours so you can choose what's right for you. Each colour features a delicate wood effect grain to give the appearance of a timber door.

As Rockdoors are 'made to order,' not 'cut to size,' all colours are available inside and out. Please check our colour swatch before ordering or use our door visualiser at [Rockdoor.com](https://www.rockdoor.com).



AGATE GREY (RAL7038)
Available with matching outerframe.



WHITE
Available with matching outerframe.



CREAM (RAL9001)
Available with matching outerframe.



BLACK (RAL8022)
Available with matching outerframe.



SAPPHIRE BLUE (RAL5011)



ANTHRACITE GREY (RAL7016)
Available with matching outerframe.



SLATE GREY (RAL7015)
Available with matching outerframe.



IRISH OAK
Available with matching outerframe.



LIGHT OAK
Available with matching outerframe.



ROSEWOOD
Available with matching outerframe.



RUBY RED (RAL3011)

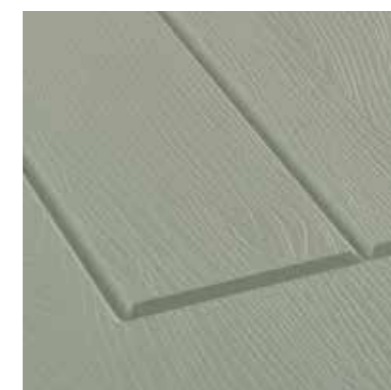

CHARTWELL GREEN
Available with matching outerframe.



EMERALD GREEN (RAL6009)

CLASSIC FURNITURE

All our classic furniture range comes with an installer backed guarantee, so not only does it perform as good as it looks, but be rest assured that the quality of our products are bound to last alongside your new Rockdoor.



ADDITIONAL FURNITURE



VICTORIAN CENTRE KNOB



URN KNOCKER WITH/WITHOUT SPY HOLE



STANDARD NUMERALS



ARCHITECTURAL KNOCKER



LETTERPLATE

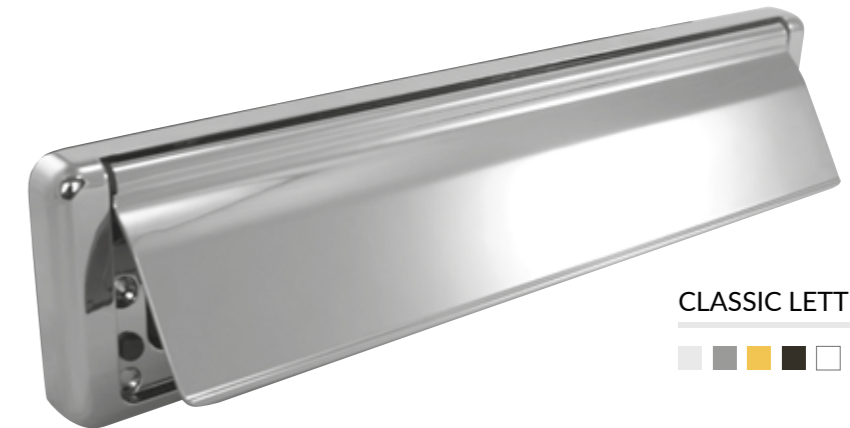

CLASSIC LETTERPLATE



LEVER HANDLES



ESCUTCHEON



LEVER/LEVER



LEVER/PAD



COLOUR KEY



WROUGHT IRON

For the ultimate, victorian charm, complete your Rockdoor with one of our expertly crafted Wrought Iron handles. These handles look incredible on wooden coloured doors.



ARCHED LEVER



TWISTED LEVER

STAINLESS FURNITURE

Crafted using high grade Stainless Steel, all furniture in this section is perfect for longevity, especially if you live near the coast.

Available colour options for each item are listed individually.



LEVER HANDLES & DOOR PULLS



Satin



Black PVD

ESCUTCHEON



LEVER/LEVER

Satin



CURVED ROSE

Satin



Satin



Polished



Black PVD



Gold

FINGER PULL



EUROPEAN ROSE

Satin

ADDITIONAL FURNITURE

LETTERPLATES

ROUNDED LETTERPLATE



Satin

CONTEMPORARY LETTERPLATE



Satin

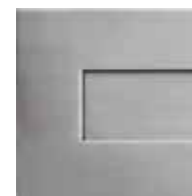

Satin



Polished



Black PVD



Gold



Satin

BULL RING KNOCKERS



Satin



Polished



Black PVD



Gold



SQUARE CENTRE KNOB

Satin



CONTEMPORARY KNOCKER

Satin



CONTEMPORARY NUMERALS

Satin

BAR HANDLES

Our bar handle range all offer a stunning satin, yet bold statement to truly complement any contemporary style of Rockdoor.

Manufactured from the same top-quality product as our Stainless Steel range, all our bar handles come with a key lock and switch latch as standard. The lock can be upgraded to an instant lock (page 73).



ROUND BAR 1200mm



ROUND BAR 900mm



ROUND BAR 600mm

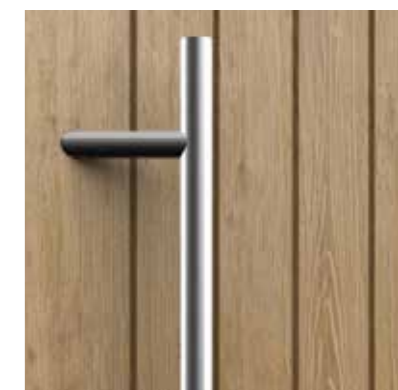

ROUND OFFSET BAR 1200mm



SQUARE BAR 1200mm



SQUARE OFFSET BAR 1200mm



SQUARE BAR BLACK 900mm



MITRED BAR 900mm

3D GLASS

Create an entrance to remember with our eye-catching range of 3D glass designs.

CLEAR (Inward or Outward)

These designs feature opposite sandblasted effects on the front or rear piece of glass for the ultimate 3D effect.

Styles:

- *Vogue Cube (Inward)*
- *Vogue Optima (Outward)*
- *Vogue Archer (Inward)*
- *Vogue Continuity (Inward)*
- *Jacobean Border (Outward)*
- *Aspen Border (Outward)*

OBSCURED

The beauty of 3D effect glass, but with a touch more privacy. These designs feature a clever use of sandblasted and sandstone glass, which work in harmony together to provide stunning effects combined with true privacy.

Styles:

- *Vogue Fluid*
- *Vogue Haze*
- *Vogue Shade*
- *Vermont Shade*
- *Vermont Haze*
- *Jacobean Shade*
- *Jacobean Fluid*
- *Newark Iris*
- *Manhattan Curve*
- *Aspen Shade*

Not all glass designs are shown in this brochure, to see all our glass designs visit rockdoor.com/designyourdoor.

BACKING GLASS

All Rockdoor glass comes double glazed at the very minimum, which means your backing glass can have a huge effect on your Doorset Energy Rating (DSER) given to your door in the homeowner pamphlet.

Choosing an obscure backing glass provides greater privacy for your home, however choosing in place of clear glass will reduce the DSER.

We recommend all designs featuring Gluechip glass are backed using clear glass to enable us to use a specially coated glass.

ADDITIONAL GLASS

In addition to our range of backing glass, we are also pleased to offer additional glass designs – please note, Georgian Bar is only available in select doors and will reduce the DSER.

Speak to your installer for more details.

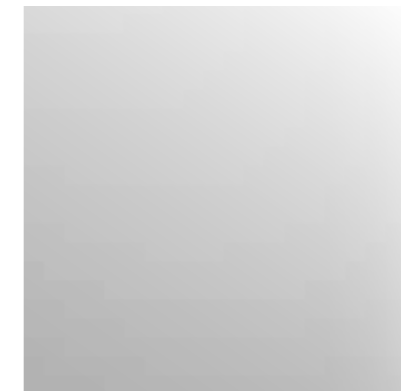

CLEAR



SANDSTONE

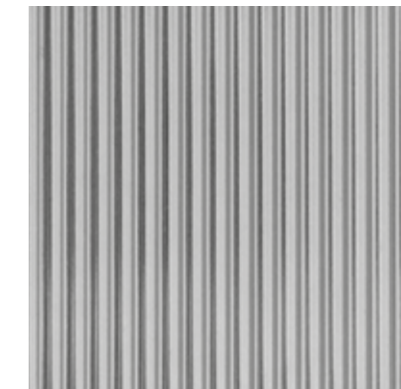

REEDED



GLACIER



HONEYCOMB



WOODLAND



MISTED
(Extra cost option)



GLUECHIP
(Random pattern) (Extra cost option)

THRESHOLDS & DRIP BARS EXPLAINED

LOW ALUMINIUM THRESHOLD

Aluminium threshold with a height of 15mm and available in gold or silver.

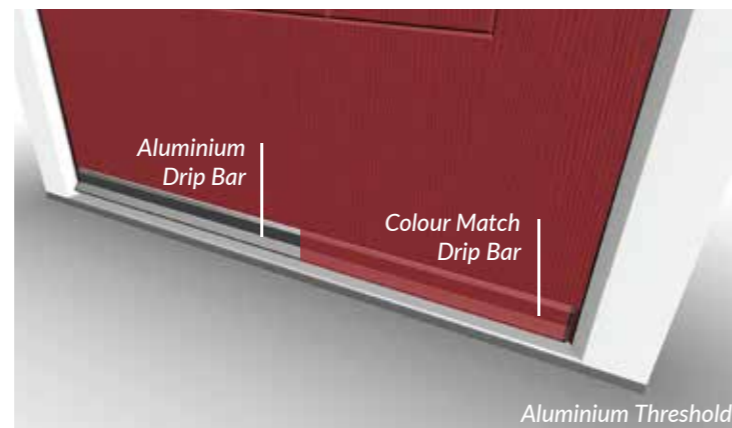
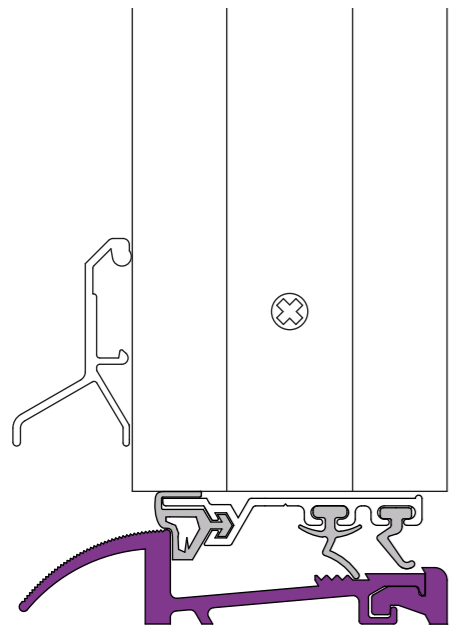

Drip bars can match the furniture or the door colour.

- Good thermal performance
- Very durable
- Suitable for wheelchair access

PVC THRESHOLD (SLIM & FULL)

PVC-U threshold available in two heights 52mm and 72mm. The colour matches the door frame.

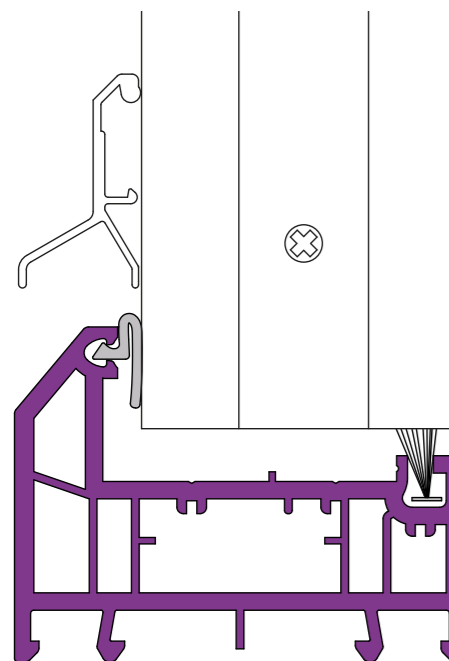

Drip bars can match the furniture or the door colour.

- Maximum thermal performance
- Works great on carpeted entrances
- 52mm provides easy access

LOCKS EXPLAINED

LEVER

- Once the handle is raised, the shootbolt and hook locks are thrown into the door frame. The door is then secured with a simple turn of the key or thumbturn lock.
- The force of raising the handle also pulls the door into the frame, ensuring compression between the frame and door sash on the seals.
- Available with lever/lever and lever/pad handles.

KEY

- To lock the door, a slight compression is needed by manually pushing the door into the frame and against the door seals.
- Then a keywind lock, or keywind 'thumbturn' lock, is needed to manually turn the lock to engage the deadbolt and hooks and secure into the outerframe.

INSTANT

- There is no need to manually lock the door with a key. It's locked automatically when magnets detect the door has been closed. This then throws the deadbolt and hook locks into the outerframe securing the door.
- Compression between the door and the frame of an instant lock isn't comparable to either handle or key operated locks, which achieve a better seal overall.

Switch latch feature comes as standard with key lock & instant lock.



NO ACCESS

When the switch is in the up position, a key is required for access.

ACCESS

When the switch is in the down position, the door can easily be pushed open.

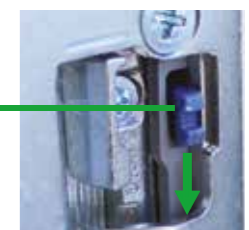

WHY ROCKDOOR IS DIFFERENT

■ HOOKS

Steel hooks with a 25mm throw engage into the reinforced outer frame.

■ ENGINEERED INNER FRAME

A welded and reinforced door skeleton is impervious to moisture ensuring it won't swell or rot.

■ REINFORCED FRAME

Rockdoor's inner frame is reinforced with aluminium making it the strongest door frame on the market.

■ CYLINDER

3 star diamond sold secure cylinders prevent forced attack.

■ DEADBOLT

Secures the sash to the outer frame acting as part of the multipoint lock.

■ HIGH DENSITY CORE

60% stronger core than a standard composite door.

MADE TO MEASURE

All our doors are made to measure and not cut to fit. Standard composite doors are cut to fit which weakens the door overall.



It's important to know what goes on under the surface of a Rockdoor, as this is what makes our door so strong and secure.

■ S-GLAZING

No cassettes eliminate glass removal, ensuring a perfect colour match and no air or water leakage. All our glass is toughened as standard.

■ STEEL SECURITY MESH

Make your door 4 times stronger and impossible to cut through with steel security mesh.

■ OUTER FRAME

PVC-U multi-chambered, insulated outer frame for high levels of thermal performance and strength.

■ STEEL KEEPS

Steel hook locks engage into full length steel keeps preventing forced entry.

■ HINGES

Engineered 3 way adjustable hinges secured into the reinforced frame for extra strength.

■ HIGH IMPACT DOOR SKINS

Thick and tough 3mm PVC-U door skins both internally and externally resist cutting and impacts.



Style Secured

UNRIVALLED CONSTRUCTION

- **UNIQUE TO ROCKDOOR**
The way a Rockdoor is designed and manufactured is what makes us stand out from the crowd.
- **STEEL SECURITY MESH**
For total security, upgrade to Steel Security Mesh reinforcing which is unique to Rockdoor.
- **STRONG INTERNAL STRUCTURE**
The inner frame of a Rockdoor is fully reinforced with a 360° Aluminium box section that makes the door super strong.

BURGLAR PROOF MULTIPOINT LOCKS

70% of burglaries involve forced entry through the front or back door. Back doors in particular are vulnerable as they are often out of sight, so a strong and secure Rockdoor front and back is important.

- **MULTIPOINT HOOKS**
Our steel hooks slide into steel keeps that run the full length of the outer frame.
- **DEADBOLT**
Our deadbolt engages into the centre of the door frame for maximum strength.
- **GEARBOX**
Our multipoint lock gearboxes ensure smooth lock functionality.



PROTECTING HOMES SINCE
1997



In fact, it's so hard to break through a Rockdoor that the Fire Service regularly visit our manufacturing facility for training on how to do so in the rare event of an emergency.

IMPOSSIBLE TO CUT THROUGH

Steel Security Mesh within a Rockdoor makes it impossible to cut through by a burglar. It is similar to the way concrete is reinforced for extra strength. Please ask your installer about this optional extra.



Can you really afford to settle for anything less?

ROCKDOOR S-GLAZE

EXCLUSIVELY FROM ROCKDOOR

All Rockdoors feature our unique S-Glaze technology. It means the glass is locked into your door for life.

This prevents forced entry through the glass as there is no glazing cassette to attack, whilst also eliminating draughts through the glazing apertures which improves the door's thermal performance.

■ ZERO FADING

Glazing cassettes which are widely used on standard composite doors, are prone to fading and discolouration.

■ LAMINATED GLASS

Whilst all our glass is toughened, we do offer customers who feel vulnerable the option to upgrade to laminated glass, often in accordance with Secured by Design. Laminated glass is two pieces of glass with a plastic inner film like a car windscreen.

THERMAL PERFORMANCE

Like your safety, your energy bills are in good hands. A combination of material choices such as PVC-U and a 50mm thick high density polyurethane core and unique manufacturing techniques such as S-Glaze Technology, allow Rockdoor to produce good thermal ratings.

REASSURINGLY SECURE



It's reassuring to read about Rockdoors security features. But we know what matters most as you lock up your home is that the only way to get past your Rockdoor is with your key.

That's why Rockdoors come with a 3 star security rating – the best there is.

■ SOLD SECURE

Sold secure diamond status - SS 312 Master Locksmith Association's highest possible rating.

■ LOCK DOWN MODE

Our cylinders are designed to go into 'lock down mode' if the attempt of forced entry is detected.

■ ANTI-SNAPPING PROTECTION

Designed to snap away if attacked, shutting down the mechanism to prevent access.

■ ANTI-DRILL PROTECTION

Our cylinder features a solid cam which is made of Molybdenum, which is stronger than steel.

£2,000
GUARANTEE



We are so confident that our lock cylinders are resistant to forced entry, that we offer a £2,000 lock guarantee. See our website for further details.

A



unleash your creativity



Design the perfect door to suit your home at [Rockdoor.com/design-your-door](https://www.rockdoor.com/design-your-door)



Need some inspiration?

■ CHECK OUT OUR 3D DOOR DESIGNER

You can now design and place your dream door right onto an image of your home, all in high-quality, 3D resolution – a very unique perspective to help you visualise how your door will truly look on your home.

■ VISIT OUR DOOR GALLERY

Struggling to decide on a style? Or maybe you can't narrow it down to a colour? Check out our extensive door gallery on Rockdoor.com to see what others have gone for, so you can make the right decision for your home.

■ HEAD TO OUR SOCIAL MEDIA

We are always active on Instagram, Facebook, Twitter and TikTok – so you can keep up to date with what's currently trending!



[Rockdoor.com](https://www.rockdoor.com)



TABLE OF CONTENTS

DOOR COLLECTIONS

Vogue	4
Manhattan	10
Jacobean	12
Newark	16
Vermont	20
Aspen	26
Indiana	28
Dakota	30
Illinois	32
Portland	34
Carolina & Tennessee	36
Windsor	38
Colonial & Regency	40
Arcacia & Kentucky	42
Georgia & Montana	43
English Cottage	44
Cottage (Spy & View Light)	46
Stable (View Light & Spy)	48
French Doors	52
Double Doors	54
Dune Vision	58
Dune Retreat	60

STYLED BY YOU

Colours	62
Classic Furniture	64
Wrought Iron Furniture	65
Stainless Furniture	66
Bar Handles	68
Glass	70
Thresholds & Drip Bars	72
Locks	73

SECURED BY US

Why Rockdoor is Different	74
Unrivalled Construction	76
Lock Security	77
S-Glaze	78
Cylinder Security (£2,000 Guarantee)	79
3D Door Designer	80
Features & Benefits	83



FEATURES & BENEFITS

With over 25 years of manufacturing history, Rockdoor are consistently at the forefront of innovation with new ideas, leading the way in terms of composite door security, thermal efficiency, and style.

Most of the foundations that Rockdoor were built are still seen today in our fantastic range of entrance doors, however over the years we have had to adjust where possible in order to stay ahead of the game, to give homeowners the best composite door available.

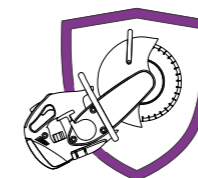

Forced Entry

Rockdoors are designed for strength, it is in our DNA. For over 25 years, we have led the way in composite door development to ensure our doors protect homes and families from unwanted intruders and forced entry.

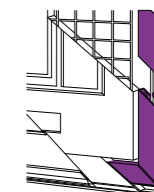

Hook up with Rockdoor

Strong steel multipoint hook locks with a 25mm throw, securely attach the door to the outer frame to ensure it cannot be forcibly opened by burglars whilst ensuring a better sound and weatherproof seal.

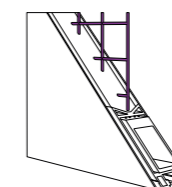

Core Benefits

Rockdoor's inner strength is unsurpassed thanks to a combination of a 360° aluminium reinforced inner frame and high-density thermally efficient PU foam. Customers can also choose steel mesh reinforcing for the ultimate in security.



Glass Leading Security

Rockdoors feature S-Glaze technology, which means your glass is locked into your door for life, for added security. It also means no glazing cassettes are used which are prone to fading and discolouration.

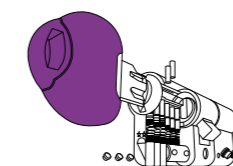

£2,000 Guarantee

Our lock cylinders are burglar proof. A TSO07 3 star rating, SS 312 Sold Secure Diamond Standard and Secured by Design accreditation see to that, plus our £2,000 security guarantee. Customers also receive three Rockdoor branded keys as standard.



Stronger, It's Official

Rockdoor is consistently found to be one of the most secure doors available in the UK, studies show that a Rockdoor is 35% stronger than a typical GRP door.

MADE IN BRITAIN

The Original Composite Door.

Established **1997**



[rockdoor.com](https://www.rockdoor.com)



All photographs, colours, and images are to be considered representative of the actual products. We reserve the right to change specifications at any time. Please check energy ratings before ordering. Furniture positioning is dependent on door style and sizes. All images copyright to Rockdoor Ltd. Rockdoor is a registered trademark. July 2023.